



# OPERATOR'S MANUAL

**Metal Working**



## MANUAL PIPE & TUBE NOTCHER MODEL: TN-125M

Baileigh Industrial Holdings LLC  
P.O. Box 531  
Manitowoc, WI 54221-0531  
Phone: 920.684.4990  
Fax: 920.684.3944  
[sales@baileigh.com](mailto:sales@baileigh.com)

REPRODUCTION OF THIS MANUAL IN ANY FORM WITHOUT WRITTEN APPROVAL OF BAILEIGH INDUSTRIAL HOLDINGS LLC IS PROHIBITED. Baileigh Industrial Holdings LLC, Inc. does not assume and hereby disclaims any liability for any damage or loss caused by an omission or error in this Operator's Manual, resulting from accident, negligence, or other occurrence.

Rev. 01/2021



## Table of Contents

THANK YOU & WARRANTY .....	1
INTRODUCTION.....	3
GENERAL NOTES.....	3
SAFETY INSTRUCTIONS .....	4
SAFETY PRECAUTIONS .....	6
Dear Valued Customer:.....	6
TECHNICAL SPECIFICATIONS .....	8
TECHNICAL SUPPORT .....	8
UNPACKING AND CHECKING CONTENTS.....	9
ASSEMBLY AND INSTALLATION.....	10
OPERATION.....	11
MATERIAL SELECTION.....	12
LUBRICATION AND MAINTENANCE .....	12



## THANK YOU & WARRANTY

Thank you for your purchase of a machine from Baileigh Industrial Holdings LLC. We hope that you find it productive and useful to you for a long time to come.

**Inspection & Acceptance.** Buyer shall inspect all Goods within ten (10) days after receipt thereof. Buyer's payment shall constitute final acceptance of the Goods and shall act as a waiver of the Buyer's rights to inspect or reject the goods unless otherwise agreed. If Buyer rejects any merchandise, Buyer must first obtain a Returned Goods Authorization ("RGA") number before returning any goods to Seller. Goods returned without an RGA will be refused. Seller will not be responsible for any freight costs, damages to goods, or any other costs or liabilities pertaining to goods returned without a RGA. Seller shall have the right to substitute a conforming tender. Buyer will be responsible for all freight costs to and from Buyer and repackaging costs, if any, if Buyer refuses to accept shipment. If Goods are returned in unsalable condition, Buyer shall be responsible for full value of the Goods. Buyer may not return any special-order Goods. Any Goods returned hereunder shall be subject to a restocking fee equal to 30% of the invoice price.

**Specifications.** Seller may, at its option, make changes in the designs, specifications or components of the Goods to improve the safety of such Goods, or if in Seller's judgment, such changes will be beneficial to their operation or use. Buyer may not make any changes in the specifications for the Goods unless Seller approves of such changes in writing, in which event Seller may impose additional charges to implement such changes.

**Limited Warranty.** Seller warrants to the original end-user that the Goods manufactured or provided by Seller under this Agreement shall be free of defects in material or workmanship for a period of twelve (12) months from the date of purchase, provided that the Goods are installed, used, and maintained in accordance with any instruction manual or technical guidelines provided by the Seller or supplied with the Goods, if applicable. The original end-user must give written notice to Seller of any suspected defect in the Goods prior to the expiration of the warranty period. The original end-user must also obtain a RGA from Seller prior to returning any Goods to Seller for warranty service under this paragraph. Seller will not accept any responsibility for Goods returned without a RGA. The original end-user shall be responsible for all costs and expenses associated with returning the Goods to Seller for warranty service. In the event of a defect, Seller, at its sole option, shall repair or replace the defective Goods or refund to the original end-user the purchase price for such defective Goods. Goods are not eligible for replacement or return after a period of 10 days from date of receipt. The foregoing warranty is Seller's sole obligation, and the original end-user's exclusive remedy, with regard to any defective Goods. This limited warranty does not apply to: (a) die sets, tooling, and saw blades; (b) periodic or routine maintenance and setup, (c) repair or replacement of the Goods due to normal wear and tear, (d) defects or damage to the Goods resulting from misuse, abuse, neglect, or accidents, (e) defects or damage to the Goods resulting from improper or unauthorized alterations, modifications, or changes; and (f) any Goods that has not been installed and/or maintained in accordance with the instruction manual or technical guidelines provided by Seller.

**EXCLUSION OF OTHER WARRANTIES.** THE FOREGOING LIMITED WARRANTY IS IN LIEU OF ALL OTHER WARRANTIES, EXPRESS OR IMPLIED. ANY AND ALL OTHER EXPRESS, STATUTORY OR IMPLIED WARRANTIES, INCLUDING BUT NOT LIMITED TO, ANY WARRANTY OF MERCHANTABILITY OR FITNESS FOR ANY PARTICULAR PURPOSE ARE EXPRESSLY DISCLAIMED. NO WARRANTY IS MADE WHICH EXTENDS BEYOND THAT WHICH IS EXPRESSLY CONTAINED HEREIN.

**Limitation of Liability.** IN NO EVENT SHALL SELLER BE LIABLE TO BUYER OR ANY OTHER PARTY FOR ANY INCIDENTAL, CONSEQUENTIAL OR SPECIAL DAMAGES (INCLUDING, WITHOUT LIMITATION, LOST PROFITS OR DOWN TIME) ARISING FROM OR IN MANNER CONNECTED WITH THE GOODS, ANY BREACH BY SELLER OR ITS AGENTS OF THIS AGREEMENT, OR ANY OTHER CAUSE WHATSOEVER, WHETHER BASED ON CONTRACT, TORT OR ANY OTHER THEORY OF LIABILITY. BUYER'S REMEDY WITH RESPECT TO ANY CLAIM ARISING UNDER THIS AGREEMENT IS STRICTLY LIMITED TO NO MORE THAN THE AMOUNT PAID BY THE BUYER FOR THE GOODS.



**Force Majeure.** Seller shall not be responsible for any delay in the delivery of, or failure to deliver, Goods due to causes beyond Seller's reasonable control including, without limitation, acts of God, acts of war or terrorism, enemy actions, hostilities, strikes, labor difficulties, embargoes, non-delivery or late delivery of materials, parts and equipment or transportation delays not caused by the fault of Seller, delays caused by civil authorities, governmental regulations or orders, fire, lightening, natural disasters or any other cause beyond Seller's reasonable control. In the event of any such delay, performance will be postponed by such length of time as may be reasonably necessary to compensate for the delay.

**Installation.** If Buyer purchases any Goods that require installation, Buyer shall, at its expense, make all arrangements and connections necessary to install and operate the Goods. Buyer shall install the Goods in accordance with any Seller instructions and shall indemnify Seller against any and all damages, demands, suits, causes of action, claims and expenses (including actual attorneys' fees and costs) arising directly or indirectly out of Buyer's failure to properly install the Goods.

**Work By Others; Safety Devices.** Unless agreed to in writing by Seller, Seller has no responsibility for labor or work performed by Buyer or others, of any nature, relating to design, manufacture, fabrication, use, installation or provision of Goods. Buyer is solely responsible for furnishing and requiring its employees and customers to use all safety devices, guards and safe operating procedures required by law and/or as set forth in manuals and instruction sheets furnished by Seller. Buyer is responsible for consulting all operator manuals, ANSI or comparable safety standards, OSHA regulations and other sources of safety standards and regulations applicable to the use and operation of the Goods.

**Remedies.** Each of the rights and remedies of Seller under this Agreement is cumulative and in addition to any other or further remedies provided under this Agreement or at law or equity.

**Attorney's Fees.** In the event legal action is necessary to recover monies due from Buyer or to enforce any provision of this Agreement, Buyer shall be liable to Seller for all costs and expenses associated therewith, including Seller's actual attorney fees and costs.

**Governing Law/Venue.** This Agreement shall be construed and governed under the laws of the State of Wisconsin, without application of conflict of law principles. Each party agrees that all actions or proceedings arising out of or in connection with this Agreement shall be commenced, tried, and litigated only in the state courts sitting in Manitowoc County, Wisconsin or the U.S. Federal Court for the Eastern District of Wisconsin. Each party waives any right it may have to assert the doctrine of "forum non conveniens" or to object to venue to the extent that any proceeding is brought in accordance with this section. Each party consents to and waives any objection to the exercise of personal jurisdiction over it by courts described in this section. Each party waives to the fullest extent permitted by applicable law the right to a trial by jury.

**Summary of Return Policy.**

- 10 Day acceptance period from date of delivery. Damage claims and order discrepancies will not be accepted after this time.
- You must obtain a Baileigh issued RGA number PRIOR to returning any materials.
- Returned materials must be received at Baileigh in new condition and in original packaging.
- Altered items are not eligible for return.
- Buyer is responsible for all shipping charges.
- A 30% re-stocking fee applies to all returns.

Baileigh Industrial Holdings LLC makes every effort to ensure that our posted specifications, images, pricing and product availability are as correct and timely as possible. We apologize for any discrepancies that may occur. Baileigh Industrial Holdings LLC reserves the right to make any and all changes deemed necessary in the course of business including but not limited to pricing, product specifications, quantities, and product availability.

**For Customer Service & Technical Support:**

Please contact one of our knowledgeable Sales and Service team members at:  
(920) 684-4990 or e-mail us at [sales@baileigh.com](mailto:sales@baileigh.com)



## **INTRODUCTION**

*The quality and reliability of the components assembled on a Baileigh Industrial Holdings LLC machine guarantee near perfect functioning, free from problems, even under the most demanding working conditions. However, if a situation arises, refer to the manual first. If a solution cannot be found, contact the distributor where you purchased our product. Make sure you have the serial number and production year of the machine (stamped on the nameplate). For replacement parts refer to the assembly numbers on the parts list drawings.*

*Our technical staff will do their best to help you get your machine back in working order.*

### **In this manual you will find: (when applicable)**

- Safety procedures
- Correct installation guidelines
- Description of the functional parts of the machine
- Capacity charts
- Setup and start-up instructions
- Machine operation
- Scheduled maintenance
- Parts lists

## **GENERAL NOTES**

After receiving your equipment remove the protective container. Do a complete visual inspection, and if damage is noted, **photograph it for insurance claims** and contact your carrier at once, requesting inspection. Also contact Baileigh Industrial Holdings LLC and inform them of the unexpected occurrence. Temporarily suspend installation.

Take necessary precautions while loading / unloading or moving the machine to avoid any injuries.

Your machine is designed and manufactured to work smoothly and efficiently. Following proper maintenance instructions will help ensure this. Try and use original spare parts, whenever possible, and most importantly; **DO NOT** overload the machine or make any modifications.



**Note:** This symbol refers to useful information throughout the manual.



## IMPORTANT

### PLEASE READ THIS OPERATORS MANUAL CAREFULLY

It contains important safety information, instructions, and necessary operating procedures. The continual observance of these procedures will help increase your production and extend the life of the equipment.

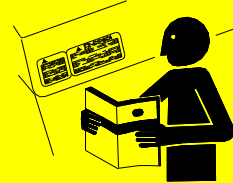

## SAFETY INSTRUCTIONS

### LEARN TO RECOGNIZE SAFETY INFORMATION

This is the safety alert symbol. When you see this symbol on your machine or in this manual, **BE ALERT TO THE POTENTIAL FOR PERSONAL INJURY!**



Follow recommended precautions and safe operating practices.

### UNDERSTAND SIGNAL WORDS

A signal word – **DANGER**, **WARNING**, or **CAUTION** – is used with the safety alert symbol. **NOTICE**, which is not related to personal injury, is used without a symbol.

**DANGER:** Indicates a hazardous situation which, if not avoided, will result in death or serious injury.

**WARNING:** Indicates a hazardous situation which, if not avoided, could result in death or serious injury.

**CAUTION:** Indicates a hazardous situation which, if not avoided, could result in minor or moderate injury.

**NOTICE:** Indicates a situation which, if not avoided, could result in property damage.

**DANGER**

**WARNING**

**CAUTION**

**NOTICE**



**SAVE THESE INSTRUCTIONS.**  
**Refer to them often and use them to instruct others.**



**PROTECT EYES**

Wear safety glasses or suitable eye protection when working on or around machinery.

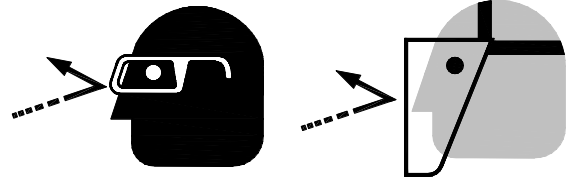

**KEEP CLEAR OF MOVING OBJECTS**

Always be aware of the position of the handle and the material. They are heavy and can swing back suddenly causing serious body or head injuries.

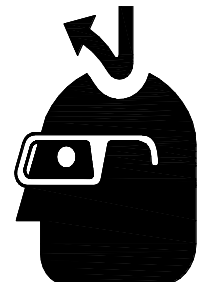

**BEWARE OF NOTCH POINTS**

Do not put your fingers into the notching holes as the cutting edges are extremely sharp.

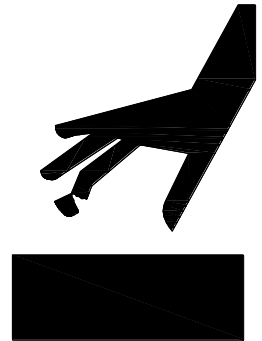

**BEWARE OF SHEAR HAZARD**

Keep hands and fingers clear from under the blade.  
**NEVER** place your hand or any part of your body in this machine.

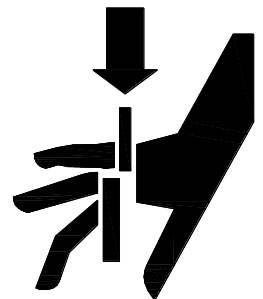

**CALIFORNIA PROPOSITION 65**

WARNING: Cancer and Reproductive Harm.  
[www.P65Warnings.ca.gov](http://www.P65Warnings.ca.gov)





## **SAFETY PRECAUTIONS**



Metal working can be dangerous if safe and proper operating procedures are not followed. As with all machinery, there are certain hazards involved with the operation of the product. Using the machine with respect and caution will considerably lessen the possibility of personal injury. However, if normal safety precautions are overlooked or ignored, personal injury to the operator may result.

Safety equipment such as guards, hold-downs, safety glasses, dust masks and hearing protection can reduce your potential for injury. But even the best guard will not make up for poor judgment, carelessness or inattention. **Always use common sense** and exercise **caution** in the workshop. If a procedure feels dangerous, don't try it.

**REMEMBER: Your personal safety is your responsibility.**



**WARNING: FAILURE TO FOLLOW THESE RULES MAY RESULT IN SERIOUS PERSONAL INJURY**

### **Dear Valued Customer:**

- All Baileigh machines should be used only for their intended use.
- Baileigh does not recommend or endorse making any modifications or alterations to a Baileigh machine. Modifications or alterations to a machine may pose a substantial risk of injury to the operator or others and may do substantial damage to the machine.
- Any modifications or alterations to a Baileigh machine will invalidate the machine's warranty.

### **PLEASE ENJOY YOUR BAILEIGH MACHINE! ....PLEASE ENJOY IT SAFELY!**

1. **FOR YOUR OWN SAFETY, READ INSTRUCTION MANUAL BEFORE OPERATING THE MACHINE.** Learn the machine's application and limitations as well as the specific hazards.
2. **Only trained and qualified personnel can operate this machine.**
3. **Make sure guards are in place and in proper working order before operating machinery.**
4. **Remove any adjusting tools.** Before operating the machine, make sure any adjusting tools have been removed.
5. **Keep work area clean.** Cluttered areas invite injuries.
6. **Overloading machine.** By overloading the machine, you may cause injury from flying parts. **DO NOT** exceed the specified machine capacities.
7. **Dressing material edges.** Always chamfer and deburr all sharp edges.



8. **Do not force tool.** Your machine will do a better and safer job if used as intended. **DO NOT** use inappropriate attachments in an attempt to exceed the machine's rated capacity.
9. **Use the right tool for the job. DO NOT** attempt to force a small tool or attachment to do the work of a large industrial tool. **DO NOT** use a tool for a purpose for which it was not intended.
10. **Dress appropriately. DO NOT** wear loose fitting clothing or jewelry as they can be caught in moving machine parts. Protective clothing and steel toe shoes are recommended when using machinery. Wear a restrictive hair covering to contain long hair.
11. **Use eye protection.** Always wear ISO approved protective eye wear when operating machinery. Wear a full-face shield if you are producing metal filings. Eye wear shall be impact resistant, protective safety glasses with side shields which comply with ANSI Z87.1 specification. Use of eye wear which does not comply with ANSI Z87.1 specification could result in severe injury from breakage of eye protection.
12. **Do not overreach.** Maintain proper footing and balance at all times. **DO NOT** reach over or across a running machine.
13. **Stay alert.** Watch what you are doing and use common sense. **DO NOT** operate any tool or machine when you are tired.
14. **Check for damaged parts.** Before using any tool or machine, carefully check any part that appears damaged. Check for alignment and binding of moving parts that may affect proper machine operation.
15. **Observe work area conditions. DO NOT** use machines in damp or wet locations. Do not expose to rain. Keep work area well lighted.
16. **Blade adjustments and maintenance.** Always keep blades sharp and properly adjusted for optimum performance.
17. **Keep children away.** Children must never be allowed in the work area. **DO NOT** let them handle machines, tools, or extension cords.
18. Keep visitors a safe distance from the work area.
19. **Store idle equipment.** When not in use, tools must be stored in a dry location to inhibit rust. Always lock up tools and keep them out of reach of children.
20. **DO NOT operate machine if under the influence of alcohol or drugs.** Read warning labels on prescriptions. If there is any doubt, **DO NOT** operate the machine.



## **TECHNICAL SPECIFICATIONS**

Notching Capacity (Pipe)	.75", 1", 1.25" (19mm, 25.4mm, 31.75mm)
Maximum Material Thickness	0.156" (4mm)
Power	Manual
Shipping Dimensions (L x W x H)	20' x 7" x 7" (508 x 178 x 178mm)
Shipping Weight	20lbs. (9kgs)

## **TECHNICAL SUPPORT**

Our technical support department can be reached at 920.684.4990 and asking for the support desk for purchased machines. Tech Support handles questions on machine setup, schematics, warranty issues, and individual parts needs: (other than die sets and blades).

For specific application needs or future machine purchases contact the Sales Department at: [sales@baileigh.com](mailto:sales@baileigh.com), Phone: 920.684.4990, or Fax: 920.684.3944.



**Note:** *The photos and illustrations used in this manual are representative only and may not depict the actual color, labeling or accessories and may be intended to illustrate technique only.*



**Note:** *The specifications and dimensions presented here are subject to change without prior notice due to improvements of our products.*



## UNPACKING AND CHECKING CONTENTS

Your Baileigh machine is shipped complete. Separate all parts from the packing material and check each item carefully. Make certain all items are accounted for before discarding any packing material.

**⚠ WARNING: SUFFOCATION HAZARD!** Immediately discard any plastic bags and packing materials to eliminate choking and suffocation hazards to children and animals.  
If any parts are missing, **DO NOT** place the machine into service until the missing parts are obtained and installed correctly.

## Cleaning

**⚠ WARNING: DO NOT USE** gasoline or other petroleum products to clean the machine. They have low flash points and can explode or cause fire.

**⚠ CAUTION:** When using cleaning solvents work in a well-ventilated area. Many cleaning solvents are toxic if inhaled.

Your machine may be shipped with a rustproof waxy coating and/or grease on the exposed unpainted metal surfaces. Fully and completely remove this protective coating using a degreaser or solvent cleaner. Moving items will need to be moved along their travel path to allow for cleaning the entire surface. For a more thorough cleaning, some parts will occasionally have to be removed. **DO NOT USE** acetone or brake cleaner as they may damage painted surfaces.

Follow manufacturer's label instructions when using any type of cleaning product. After cleaning, wipe unpainted metal surfaces with a light coating of quality oil or grease for protection.



**Important:** This waxy coating is **NOT** a lubricant and will cause the machine to stick and lose performance as the coating continues to dry.





## **ASSEMBLY AND INSTALLATION**

### **IMPORTANT:**

Consider the following when looking for a suitable location to place the machine:

- Overall weight of the machine.
- Weight of material being processed.
- Sizes of material to be processed through the machine.
- Space needed for auxiliary stands, worktables, or other machinery.
- Clearance from walls and other obstacles.
- Maintain an adequate working area around the machine for safety.
- Have the work area well illuminated with proper lighting.
- Keep the floor free of oil and make sure it is not slippery.
- Remove scrap and waste materials regularly, and make sure the work area is free from obstructing objects.
- If long lengths of material are to be fed into the machine, make sure that they will not extend into any aisles.

When mounting the Baileigh notcher on a workbench or to a column or post, be aware of the following:

- Overall weight of the machine and the weight of material being processed.
- Make sure the workbench is properly reinforced to support the total weight.
- The strongest mounting option is where the holes are drilled all the way through the workbench and the machine is secured with bolts, washers, and nuts.
- This Tube and Pipe Notcher requires some assembly.
- After unpacking, lay out the pieces on a table or bench. Refer to the photo to the right and the part identification drawing to complete the assembly.
- Make sure the mounting surface is substantial enough to adequately support the notcher and the forces used during operation.
- Four bolts, nuts, and flat washers are provided to mount the TN-125M notcher.
- Be sure to provide enough clearance around the notcher for the stroke of the handle. When mounted vertically the notch slugs will fall out of the holes. The notcher can also be mounted on a horizontal surface.





## OPERATION

 **CAUTION:** Always wear proper eye protection with side shields, safety footwear, and leather gloves to protect from burrs and sharp edges.

 **CAUTION:** When handling large heavy tube or pipe make sure they are properly supported.

The Baileigh **TN-125M** Pipe and Tube Notcher is a special tool used to cope size 0.75", 1", and 1.25" pipe with a maximum wall thickness of 0.156" (4mm). This notcher is based upon a nibbler design. While most notching may be completed at full depth, if the material is difficult to notch, especially at a weld seam, it is recommended to proceed in two or more cuts.

1. Lightly lubricate the cutter using a lightweight oil similar to a WD-40.
2. Clean the end of the pipe to remove dirt, burrs, metal chips and any foreign materials. These types of items may cause the blade to stick and not return freely.
3. Place the end of the pipe into the correct sized hole until it contacts the stop and pull down on the handle.



*Important:* After a cut is made the scrap will usually fall through to the bottom of the machine. The scrap may be distorted from the cut and not fall through. This will cause the blade to stick and not return to the open position. Stop and lightly tap on the cutter body with a soft mallet to free the lodged piece.

4. After the first cut has been made, remove the pipe.
5. Verify that the slug has been removed from the notcher and then rotate and reposition the pipe as desired or move to the next piece for the next cut.
6. Lightly lubricate the cutter after every 10-12 cuts. Use a lightweight oil similar to a WD-40. Lubricate just enough to keep the blade wet but not enough to drip.



*Note:* Only one piece of pipe should be cut at a time.



## MATERIAL SELECTION

 **CAUTION:** It must be determined by the customer that materials being processed through the machine are **NOT** potentially hazardous to operator or personnel working nearby.

When selecting materials keep these instructions in mind:

- Material must be clean and dry. (without oil)
- Material should have a smooth surface so it processes easily.
- Dimensional properties of material must be consistent and not exceed the machine capacity values.
- Chemical structure of material must be consistent.
- Buy certificated steel from the same vendor when possible.

## LUBRICATION AND MAINTENANCE

 **WARNING:** Maintenance should be performed on a regular basis by qualified personnel.  
Always follow proper safety precautions when working on or around any machinery.

- Check daily for any unsafe conditions and fix immediately.
- Check that all nuts and bolts are properly tightened.
- On a weekly basis clean the machine and the area around it.
- Lubricate threaded components and sliding devices.
- Apply rust inhibitive lubricant to all non-painted surfaces.



**Note:** *Proper maintenance can increase the life expectancy of your machine.*



**PARTS DIAGRAM**

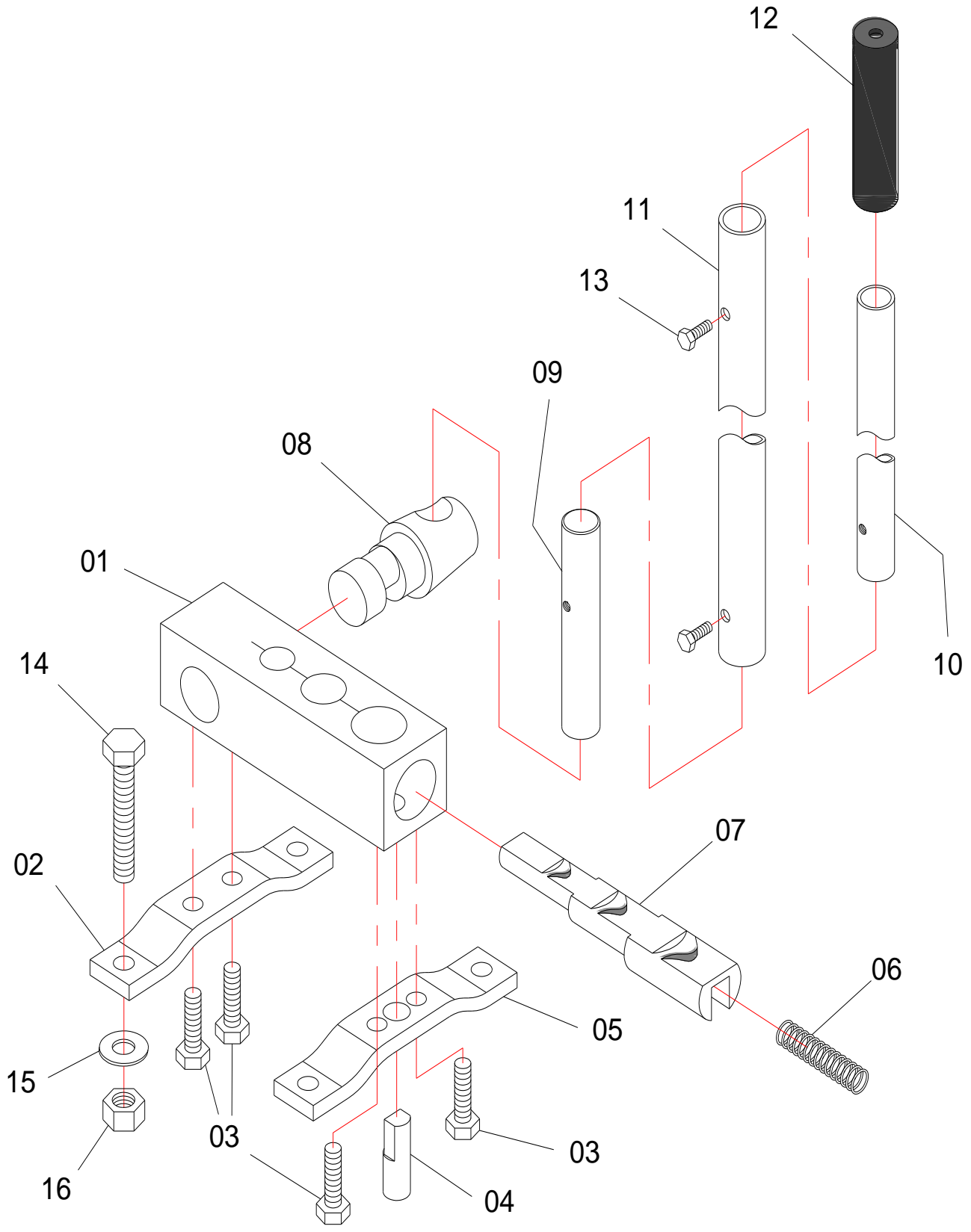



**Parts List**

Item	Part No.	Description	Qty.
01	TN125M-1	Body	1
02	TN125M-2	Front Support	1
03	TN125M-3	Hex Cap Screw M10 x 20mm	4
04	TN125M-4	Pin	1
05	TN125M-5	Back Support	1
06	TN125M-6	Compression Spring	1
07	TN125M-7	Cutting Block	1
08	TN125M-8	Eccentric Shaft	1
09	TN125M-9	Handle Pin	1
10	TN125M-10	Upper Handle	1
11	TN125M-11	Lower Handle	1
12	TN125M-12	Handle Grip	1
13	TN125M-13	Hex Cap Screw M6 x 14mm	2
14	TN125M-14	Hex Cap Screw M10 x 75mm	4
15	TN125M-15	Flat Washer M10	4
16	TN125M-16	Hex Nut M10	4

**BAILEIGH INDUSTRIAL HOLDINGS LLC**  
**1625 DUFEK DRIVE MANITOWOC, WI 54220**  
**PHONE: 920. 684. 4990 FAX: 920. 684. 3944**  
**[www.baileigh.com](http://www.baileigh.com)**